

# Sanoasa Bellina wellness benches

## **NEW** Sanoasa *Bellino* | wellness benches, slope to front

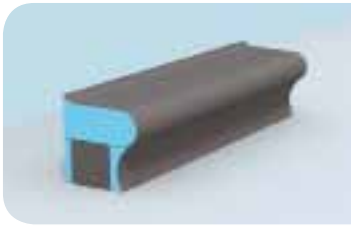

Description	Length	Order no.
Sanoasa Bellina, bench element, slope to front	1000 mm	07-64-48/015
Sanoasa Bellina, bench element, slope to front	2000 mm	07-64-41/000
Sanoasa Bellina, carrier element, round finish length	1000 mm	07-64-41/600

### Options

Bench element with integrated electrical heating set	2000 mm	–
Bench element with integrated hot water heating set	2000 mm	–

-  • Each bench element requires two carrier elements.
- The bench element shall be glued to the carrier element using wedi 610 adhesive sealant (Page 60).
- For hot water or electrical heating sets which are to be installed on site, the delivery time is approx. 4–5 weeks.

### Bench element (for 2000 mm length):

- Front: approx. 2.30 m<sup>2</sup>
- Rear panel: approx. 0.50 m<sup>2</sup>
- Sides: approx. 0.19 m<sup>2</sup>

### Carrier elements (for 2000 mm length):

- Front: approx. 0.60 m<sup>2</sup>
- Rear panel: approx. 0.50 m<sup>2</sup>
- Sides: approx. 0.19 m<sup>2</sup>

### Technical drawings

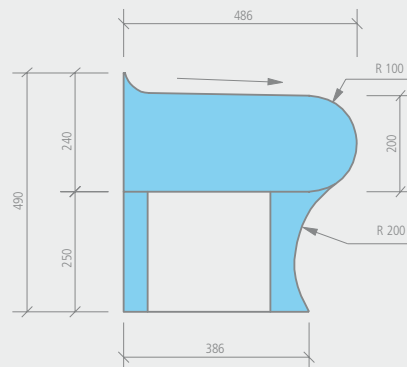

## Sanoasa Bellina wellness benches

### NEW Sanoasa *Bellina* *linea* | wellness benches, slope to front

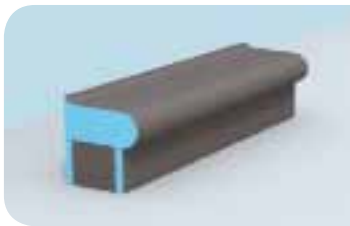

Description	Length	Order no.
Sanoasa Bellina, bench element, slope to front	1000 mm	07-64-48/015
Sanoasa Bellina, bench element, slope to front	2000 mm	07-64-41/000
Sanoasa Bellina <i>linea</i> , carrier element, straight finish length	1000 mm	07-64-41/500

Options		
Bench element with integrated electrical heating set	2000 mm	–
Bench element with integrated hot water heating set	2000 mm	–

- ! Each bench element requires two carrier elements.
- The bench element shall be glued to the carrier element using wedi 610 adhesive sealant (Page 60).
- For hot water or electrical heating sets which are to be installed on site, the delivery time is approx. 4–5 weeks.

- m<sup>2</sup>** Bench element (for 2000 mm length):
- Front: approx. 2.30 m<sup>2</sup>
  - Rear panel: approx. 0.50 m<sup>2</sup>
  - Sides: approx. 0.19 m<sup>2</sup>
- Carrier elements (for 2000 mm length):
- Front: approx. 0.60 m<sup>2</sup>
  - Rear panel: approx. 0.50 m<sup>2</sup>
  - Sides: approx. 0.20 m<sup>2</sup>

#### Technical drawings

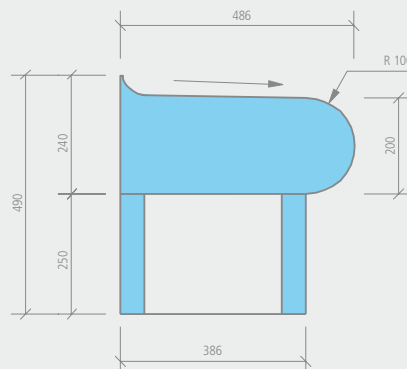

# Sanoasa *Bellina linea* | corner element 90°, straight, slope to front

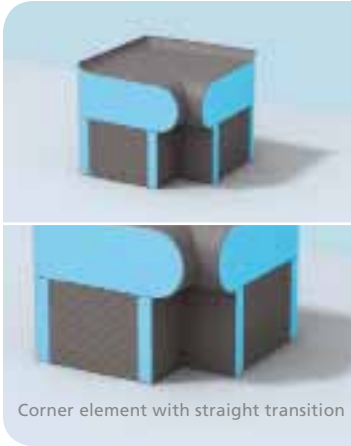

Corner element with straight transition

## Description

Sanoasa Bellina, bench element 90°, straight, slope to front

Sanoasa Bellina *linea*, carrier corner element 90°

Length x width x height

Order no.

550 x 550 x 240 mm

07-64-48/004

550 x 550 x 250 mm

07-64-48/005

**!** • The bench element shall be glued to the carrier element using wedi 610 adhesive sealant (Page 60).

## m<sup>2</sup> Bench corner element:

- Front: approx. 0.35 m<sup>2</sup>
- Rear panel: approx. 0.30 m<sup>2</sup>
- Sides: approx. 0.19 m<sup>2</sup>

## Carrier corner element:

- Front: approx. 0.10 m<sup>2</sup>
- Rear panel: approx. 0.30 m<sup>2</sup>
- Sides: approx. 0.20 m<sup>2</sup>

## Technical drawings

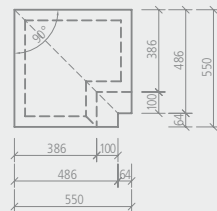
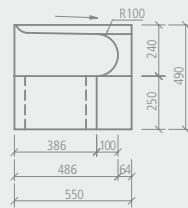

## Sanoasa Bellina wellness benches

### Sanoasa *Bellino linea* | corner element 90°, round, slope to front

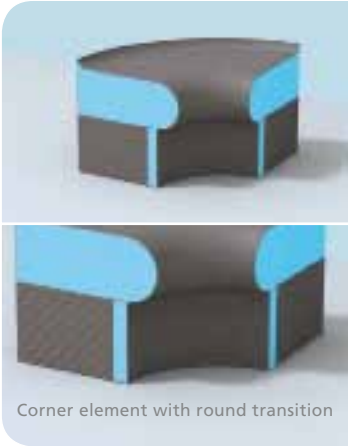

#### Description

Sanoasa Bellina, bench element 90°, round, slope to front

Sanoasa Bellina *linea*, carrier corner element 90°

Length x width x height

Order no.

736 x 736 x 240 mm

07-64-48/000

736 x 736 x 250 mm

07-64-48/001

**!** • The bench element shall be glued to the carrier element using wedi 610 adhesive sealant (Page 60).

**m²** Bench corner element:

- Front: approx. 0.45 m²
- Rear panel: approx. 0.30 m²
- Sides: approx. 0.19 m²

Carrier corner element:

- Front: approx. 0.15 m²
- Rear panel: approx. 0.30 m²
- Sides: approx. 0.20 m²

#### Technical drawings

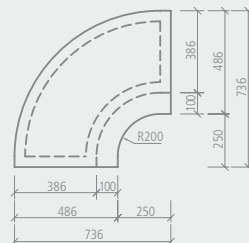
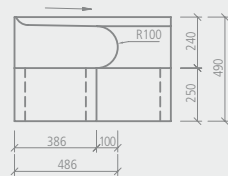

# Sanoasa *Bellina linea* | corner element 135°, straight, slope to front



Corner element with straight transition

## Description

Sanoasa Bellina, bench element 135°, straight, slope to front

Sanoasa Bellina *linea*, carrier corner element 135°

Length x width x height

Order no.

486 x 486 x 240 mm

07-64-48/006

486 x 386 x 250 mm

07-64-48/007

**!** • The bench element shall be glued to the carrier element using wedi 610 adhesive sealant (Page 60).

## **m²** Bench corner element:

- Front: approx. 0.25 m²
- Rear panel: approx. 0.15 m²
- Sides: approx. 0.19 m²

## Carrier corner element:

- Front: approx. 0.10 m²
- Rear panel: approx. 0.15 m²
- Sides: approx. 0.20 m²

## Technical drawings

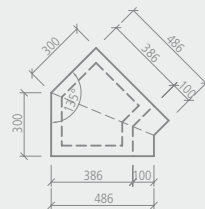
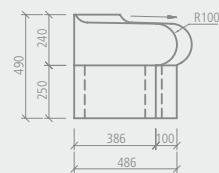

## Sanoasa Bellina wellness benches

### Sanoasa *Bellina linea* | corner element 135°, round, slope to front

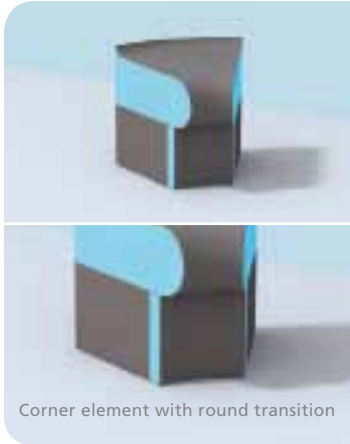

#### Description

Sanoasa Bellina, bench element 135°, round,, slope to front

Sanoasa Bellina *linea*, carrier corner element 135°

Length x width x height

Order no.

638 x 608 x 240 mm

07-64-48/002

638 x 486 x 250 mm

07-64-48/003

**!** • The bench element shall be glued to the carrier element using wedi 610 adhesive sealant (Page 60).

**m<sup>2</sup>** Bench corner element::

- Front: approx. 0.35 m<sup>2</sup>
- Rear panel: approx. 0.20 m<sup>2</sup>
- Sides: approx. 0.19 m<sup>2</sup>

Carrier corner element:

- Front: approx. 0.15 m<sup>2</sup>
- Rear panel: approx. 0.20 m<sup>2</sup>
- Sides: approx. 0.20 m<sup>2</sup>

#### Technical drawings

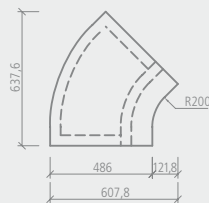
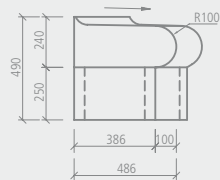

# Sanoasa *Bellina linea* | end element, left, R=200, slope to front



## Description

Sanoasa Bellina, bench end element left, R=200,  
slope to front

Sanoasa Bellina *linea*, carrier end element, left, R=200

Length x width x height

Order no.

486 x 300 x 240 mm

07-64-48/011

386 x 200 x 250 mm

07-64-48/013

**!** • The bench element shall be glued to the carrier element using wedi 610 adhesive sealant (Page 60).

**m<sup>2</sup>** Bench end element:

- Front: approx. 0.30 m<sup>2</sup>
- Rear panel: approx. 0.20 m<sup>2</sup>
- Sides: approx. 0.19 m<sup>2</sup>

Carrier end element:

- Front: approx. 0.15 m<sup>2</sup>
- Rear panel: approx. 0.15 m<sup>2</sup>
- Sides: approx. 0.20 m<sup>2</sup>

## Technical drawings

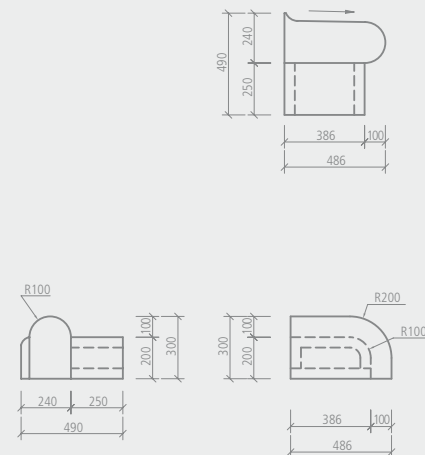

## Sanoasa Bellina wellness benches

### Sanoasa *Bellina linea* | end element, left, R=486, slope to front



#### Description

Sanoasa Bellina, bench end element, left, R=486, slope to front

Sanoasa Bellina *linea*, carrier end element, R=486

Length x width x height

Order no.

600 x 486 x 240 mm

07-64-48/008

500 x 386 x 250 mm

07-64-48/010

**!** • The bench element shall be glued to the carrier element using wedi 610 adhesive sealant (Page 60).

**m<sup>2</sup>** Bench end element:

- Front: approx. 0.40 m<sup>2</sup>
- Rear panel: approx. 0.20 m<sup>2</sup>
- Sides: approx. 0.19 m<sup>2</sup>

Carrier end element:

- Front: approx. 0.20 m<sup>2</sup>
- Rear panel: approx. 0.25 m<sup>2</sup>
- Sides: approx. 0.20 m<sup>2</sup>

#### Technical drawings

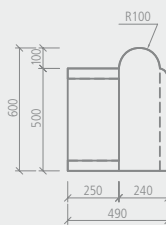
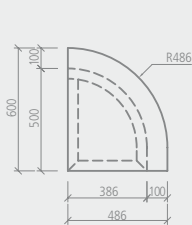
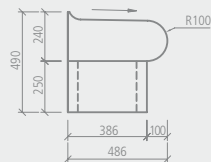

# Sanoasa *Bellina linea* | end element, right, R=200, slope to front



## Description

Sanoasa Bellina, bench end element, right, R=200,  
slope to front

Sanoasa Bellina *linea*, carrier end element, right, R=200

Length x width x height

Order no.

486 x 300 x 240 mm

07-64-48/012

386 x 200 x 250 mm

07-64-48/013

**!** • The bench element shall be glued to the carrier element using wedi 610 adhesive sealant (Page 60).

**m<sup>2</sup>** Bench end element:

- Front: approx. 0.30 m<sup>2</sup>
- Rear panel: approx. 0.20 m<sup>2</sup>
- Sides: approx. 0.19 m<sup>2</sup>

Carrier end element:

- Front: approx. 0.15 m<sup>2</sup>
- Rear panel: approx. 0.15 m<sup>2</sup>
- Sides: approx. 0.20 m<sup>2</sup>

## Technical drawings

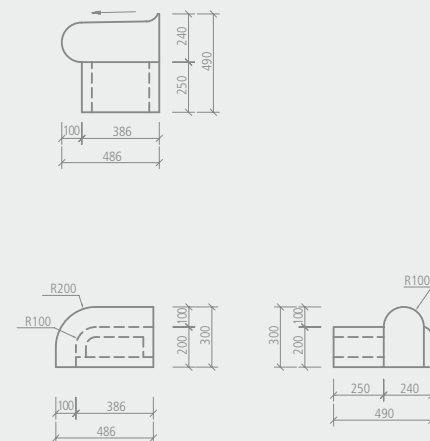

## Sanoasa Bellina wellness benches

### Sanoasa *Bellina linea* | end element, right, R=486, slope to front



#### Description

Sanoasa Bellina, bench end element right, R=486, slope to front

Sanoasa Bellina *linea*, carrier end element, R=486

Length x width x height

Order no.

600 x 486 x 240 mm

07-64-48/009

500 x 386 x 250 mm

07-64-48/010

**!** • The bench element shall be glued to the carrier element using wedi 610 adhesive sealant (Page 60).

**m<sup>2</sup>** Bench end element:

- Front: approx. 0.40 m<sup>2</sup>
- Rear panel: approx. 0.20 m<sup>2</sup>
- Sides: approx. 0.19 m<sup>2</sup>

Carrier end element:

- Front: approx. 0.20 m<sup>2</sup>
- Rear panel: approx. 0.25 m<sup>2</sup>
- Sides: approx. 0.20 m<sup>2</sup>

#### Technical drawings

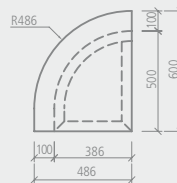
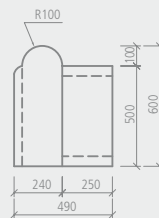
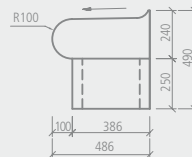

## Sanoasa *Bellina & Bellina* <sup>linea</sup> | armrest

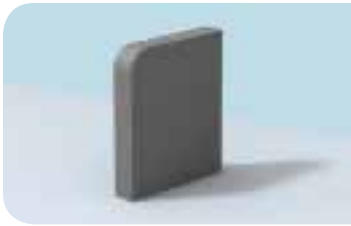

### Description

Sanoasa Bellina & Bellina <sup>linea</sup>, armrest

Length x width x height

550 x 105 x 650 mm

Order no.

07-64-48/014

- ! • The Sanoasa Bellina & Bellina <sup>linea</sup> armrest can be installed equally on the right or the left.
- The armrest must be glued to the bench element and carrier element using wedi 610 adhesive sealant (Page 60).

### m<sup>2</sup> Armrest:

- Front: approx. 0.65 m<sup>2</sup>
- Rear panel: approx. 0.10 m<sup>2</sup>
- Sides: approx. 0.72 m<sup>2</sup>

### Technical drawings

